

Ranger Pro Wireless Condition Monitoring Datasheet

Bently Nevada Machinery Condition Monitoring

125M5237 Rev. H



Description

The Ranger Pro Wireless Condition Monitoring vibration sensor allows you to monitor velocity, acceleration, and temperature plus timebase waveforms, spectra, and PeakDemod spectrum. It's built for plant managers and operators in power generation, oil and gas, and related industrial markets.

The Bently Nevada Ranger Pro Wireless Condition Monitoring sensor enables you to:

- Monitor and optimize the reliability of low- and medium-criticality machines.
- Establish or expand existing reliability programs.
- Make maintenance decisions based on current data.
- Reduce maintenance costs.
- Decrease unplanned machine failures.
- Increase machinery life.

Ranger Pro Wireless Condition Monitoring is a simple, easy to implement solution for use in hazardous or difficult to access environments where wired solutions are impractical.

Use the Ranger Pro Wireless Condition Monitoring to get immediate notifications, short- and long-term trending data, and diagnostic reporting. No more "reporting by walking around."

Quickly publish overall data through Modbus to third-party tools or spectra and waveform data through Generic Client or Hart IP Interface to Bently Nevada System 1 software. Configure Ranger Pro devices over-the-air using third-party tools or the Ranger Pro Configuration software.



Machinery Applications

Ranger Pro Wireless Condition Monitoring is a vibration sensor for machines with roller-element bearings including:

- Agitators
- Air compressors
- Ball mills
- Blowers
- Centrifuges
- Cooling tower fans and pumps
- Motors
- Small reciprocating compressors
- Small hydro and steam turbines

Hardware Features

You can configure Ranger Pro Wireless Condition Monitoring to work in a variety of environments and applications.

- Uniaxial and tri-axial capable velocity and acceleration detection.
- Environment temperature reporting.
- Mounting hardware options to fit most applications.
- Replaceable lithium-thionyl chloride battery.
- IP67 dust and water resistant.
- Embedded sensors connect using the ISA100 wireless or WirelessHART network protocols.
- Can act as a router for other Ranger Pro sensors.

Wireless range varies depending on environmental obstacles, gateway antenna type, and the orientation of the sensor relative to the gateway antenna.

System 1 Support

After installing Ranger Pro devices, you can set a start time for multiple devices to begin data acquisition using Ranger Pro Configuration Software.

Ranger Pro collects overall vibration, temperature measurements, timebase waveforms, spectra, and Peak Demod spectrum using Generic Client Interface (GCI) for ISA100 Ranger Pro devices and HART IP for WirelessHART Ranger Pro devices with System 1 software. You can filter overall and dynamic timebase and spectra data.

Network Installation

A typical network installation uses several Ranger Pro Wireless Condition Monitoring sensors, Ranger Pro repeaters, wireless device managers, and access points. Ranger Pro is available in either uniaxial or tri-axial vibration detection.

You can use third-party tools or the Ranger Pro Configuration software to quickly provision and configure Ranger Pro devices over-the-air.

Hazardous Area Approvals

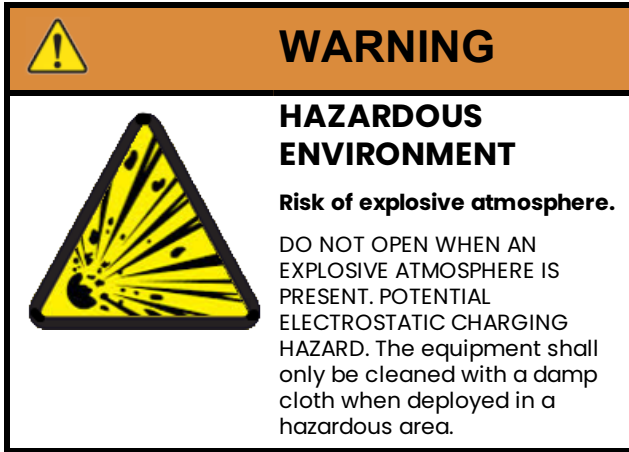

Compliance and Certifications

This device complies with part 15 of the FCC Rules. Operation is subject to the following two conditions:

1. This device may not cause harmful interference.
2. This device must accept any interference received, including interference that may cause undesired operation.

CSA	Class I, Division 1 Groups A, B, C, D
ATEX/IECEx	Standards Ex ia IIC T4 Gc Ex ia I Ma
RoHS	Directives 2011/65/EU

Specifications

Feature	Characteristic	Value
Accelerometers	Axis	1 or 3 axis (ISA100) 3 axis only (WirelessHART)
	Sensing element	Piezoelectric ceramic
	Amplitude range	±20 g peak
	Measurement accuracy	±5% (160 Hz) Z-axis ±10% (160 Hz) X and Y axis
	Transverse sensitivity (Typ.)	7%

Feature	Characteristic	Value
Trending Variables	Acceleration	
	Acceleration frequency range	Z axis: 5 Hz (± 3 dB) to 10 kHz (± 3 dB) X and Y axis: 5 Hz (± 3 dB) to 4 kHz (± 3 dB) (tri-axial sensor only)
	Acceleration amplitude range	0 – 200 m/s ² (0 - 20 g)
	Acceleration units / subunits	g or m/s ² / peak or rms
	Fmin	2, 5, 10, 100, 200 (Hz)
	Fmax	200, 500, 1000, 2000, 5000, 10000 \ddagger Hz \ddagger 10,000 only on Z-axis
	Velocity	
	Velocity frequency range	5 – 2000 Hz
	Velocity amplitude range	0 – 50 mm/s (0 - 2 in/s)
	Velocity units / subunits	in/s or mm/s peak or rms
	Fmin	5, 10 Hz
	Fmax	200, 500, 1000, 2000 Hz
	Peak Demod	
	Peak Demod Pk	Z axis only Parameters based on PeakDemod Spectrum settings below
	Measurement interval	6, 8, 12, 24, 48, 168, 336, 672 hours
	Output data	Overall values using: <ul style="list-style-type: none"> • Modbus from device gateway • Generic Client Interface (GCI) for ISA100 devices • HART IP for WirelessHART

Feature	Characteristic	Value
Waveforms and Spectra	Acceleration	
	Acceleration waveform	X, Y and Z axis depending on sensor model
	Fmin	2, 5, 10 Hz
	Fmax	200, 500, 1000, 2000, 5000, 10000 † Hz ‡ Z-axis only
	Number of samples	1024, 2048, 4096, 8192
	Units/subunits	g or m/s ² / peak
	Velocity	
	Velocity spectra	X, Y and Z axis depending on sensor model
	Fmin	5, 10
	Fmax	200, 500, 1000, 2000
	Number of lines	400, 800, 1600, 3200
	Units/subunits	in/s or mm/s / rms
	Peak Demod	
	Peak Demod spectrum	Z-Axis only
	Fmax	200, 500, 1000, 2000, 5000 Hz
	Demod Band Min	500, 1000, 2000, 5000 Hz Max 40000 Hz
	Units/subunits	g, m/s ² / peak
	Waveforms and spectra measurement intervals	6, 8, 12, 24, 48, 168, 336, 672 hours
	Output data	Waveforms and spectra via: <ul style="list-style-type: none"> • Generic Client Interface (GCI) for ISA100 • HART IP for WirelessHART
Temperature sensor	Measurement range	-40 °C to 120 °C (-40 °F to 248 °F) (Temperature sensor range. Not to be confused with allowable operating temperatures. Limited by battery and ambient conditions.)
	Resolution	0.1 °C (°F)

Feature	Characteristic	Value					
	Output data	Overall values using: <ul style="list-style-type: none"> • Modbus from device gateway • Generic Client Interface (GCI) for ISA100 devices • HART IP for WirelessHART 					
Wireless	Network standard	ISA100.11a, WirelessHART					
	Network topology	Star (ISA100) or mesh (ISA100 or WirelessHART)					
	Radio standard	IEEE 802.15.4					
	Radio frequency	2.45 GHz ISM band					
	Provisioning/ firmware updates	Over-the-air or via the USB docking station.					
	Encryption/ security	128-bit AES encrypted packets					
	Output power (peak)	10 mW, maximum					
	Maximum RF Output Power	4 mW/MHz					
	Wireless range	150 meters sensor to access point, 100 meters sensor to sensor, line of sight. (Actual range depends on obstacles present, gateway antenna type, and orientation of the sensor relative to the gateway antenna.)					
Battery and Power	Type	Replaceable D size 3.6V lithium-thionyl chloride. <div style="border: 1px solid black; padding: 5px; margin-top: 10px;">  Warning: Use only one of the following batteries: Tadiran TLH-5930/S, Tadiran TL-5930/S, Tadiran SL-2780, or Xeno Energy XL-205F. </div>					
	Life	Up to five years depending on the operating mode and configuration.					
	Hazardous area temperature range (Ta)	<table border="1" style="width: 100%; border-collapse: collapse;"> <thead> <tr> <th style="text-align: left;">Battery models</th> <th style="text-align: left;">Temperature range</th> </tr> </thead> <tbody> <tr> <td>TLH-5930/S</td> <td>-40 °C < Ta < 80 °C</td> </tr> <tr> <td>TL-5930/S, Xeno XL-205F, Tadiran SL-2780</td> <td>-40 °C < Ta < 70 °C</td> </tr> </tbody> </table>	Battery models	Temperature range	TLH-5930/S	-40 °C < Ta < 80 °C	TL-5930/S, Xeno XL-205F, Tadiran SL-2780
Battery models	Temperature range						
TLH-5930/S	-40 °C < Ta < 80 °C						
TL-5930/S, Xeno XL-205F, Tadiran SL-2780	-40 °C < Ta < 70 °C						
Operating conditions	Operating temperature	-40 °C to 85 °C (-40 °F to 185 °F) (Operating at extreme temperatures or beyond negatively affects battery life and may damage the sensor.)					

Feature	Characteristic	Value
	Vibration limit	20 g peak
	Chemical resistance	Stainless steel and high temperature, solvent- and UV-resistant PPS plastic.
	Shock resistance	0.5 meter drop onto concrete
	Altitude	Maximum 3,000 m (9,842 ft.) outdoors
Physical	Weight	230 grams (without battery; 300 grams with battery)
	Dimensions	Height: 88 mm; diameter: 40 mm
	Case material	316 stainless steel body and glass-reinforced, impact-resistant PPS top
	Mounting hole	M6 x 1mm X 5mm deep internal thread
	IP rating	IP67 dust and water resistant
Regulatory compliance	EMC conformity standards	IEC 61326-1, ETSI EN 301 489-1, CISPR22, ETSI EN 301 489-17
	Radio spectrum	ETSI EN 300 328
	Safety	ETSI EN 61010-1, IEC 62479
	Hazardous Atmosphere	CSA Class 1 Division 1 Groups A, B, C, D T4 ATEX/IECEx Zone 0
	Conformity	Compliant with all CE and FCC/IC requirements
	Valid for RangerPro BN P/N	121M6466, 121M6469, 121M6470 147M7136-02-01 (pending)
ISA100a compatible gateways	Yokogawa	YFGW 410 Field Wireless Management Station
		YFGW 510 Field Wireless Access Points
	Honeywell	WDM Wireless Device Manager R310.2-4 or newer
		FDAP Field Device Access Point
WirelessHART compatible gateways.†	Emerson 1410	1410 (compatible with firmware version 4.7.84 or newer)
	Emerson 1420	1420 (compatible with firmware version 4.7.84 or newer)
	Honeywell	Honeywell WDM R310.2-4 or newer (pending)
† Generic Client Interface (GCI) or HART IP required. Order when new or license as necessary.		
Advanced Features		
Data on Demand	Mode	User-initiated. Acquisition initiated from Ranger Pro Configuration Software.

Feature	Characteristic	Value
	Status	Idle, Requested or Busy
Data on Vibration	Threshold	User settings. Range: 0 to 0.1 in/s rms
	Mode	Enabled/Disabled
	Detection	XYZ vector sum or Z axis only
	Status	On or Off
Data on Severity	Mode	Enabled/Disabled
	TA Proven Method Level 3	User settings. Range: 0.05 to 2.5 in/s rms
	TA Proven Method Level 4	User settings. Range: 0.05 to 2.5 in/s rms
	Detection	XYZ vector sum or Z axis only
	Status	Green, Yellow or Red when enabled



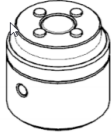
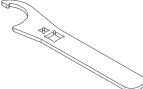
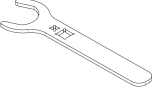

Accessories



The installation kit (130M5452) includes a battery installation tool, two installation wrenches, spare O-rings, and USB docking station. These parts can also be ordered individually.

Product or Document	Item	
138M0302	Ranger Pro e-module retaining ring and O-ring kit	
121M7993	Battery installation tool	
121M7994	C-spanner wrench, for Ranger Pro Wireless Condition Monitoring sensor and M6x1 to 1/4-28 and M6x1 to 3/8-24 25 tri-axial alignment stud	
121M7995	Wrench, for M6x1 to M8x1.25 tri-axial alignment stud	
129M0166	Sony USB configuration docking station	
146M4035	Case O-ring 35 x 1mm (qty. 20)	
146M4036	E-module O-ring 34 x 1mm (qty. 20)	
125M3923	Xeno XL-205F D-size lithium-thionyl chloride 3.6V battery	
121M7997	Ranger Pro Wireless Condition Monitoring configuration software (available for download from BN Technical Support)	
125M6113	Ranger Pro Wireless Condition Monitoring User Guide	
125M7374	Ranger Pro Wireless Condition Monitoring Quick Start Guide	

Spare Mounting Adapters

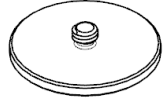
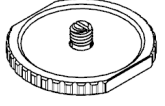
Illustrations shown are not to scale. All mounting adapters are made from 316 stainless steel.

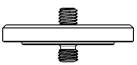
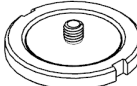
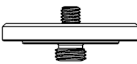
Part Number	Size	Illustration
Standard Studs		
121M7987	M6x1 to M6x1 stud	
121M7988	M6x1 to 1/4-28 adapter stud	
121M7989	M6x1 to M8x1.25 adapter stud	
121M7990	M6x1 to 10-32 adapter stud	
125M3920	M6x1 to 3/8-24 adapter stud	
Universal Magnetic Mounting Adapter		
02200371	1.85" Ø x 1.09" H (47 x 27.7 mm), 100 lbf (45kg) pull, 2-pole, 1/4-28 female UNF thread. Requires mounting option A04.	
Cementing Pads and Adhesive		
121M7991	M6x1 epoxy cementing pad	
167236-01	3.5 g Click Bond CB200 acrylic adhesive for use with epoxy cementing pads. Sufficient for about four pads.	
Tri-axial Alignment Studs		
121M7986	M6x1.0 to M8x1.25	

Part Number	Size	Illustration	
125M3921	M6x1 to ¼-28		
125M3922	M6x1 to 3/8-24		
143M5507	M6x1 epoxy mount alignment stud		



Expect a decrease in XY accuracy when using friction alignment studs.

Ordering Information



For the detailed listing of country and product specific approvals, refer to the *Approvals Quick Reference Guide* (108M1756) available from Bently.com.

Ranger Pro Tri-Axial Sensor ISA100

70M303 – AA-BB-CC-DD

Description: Tri-axial wireless accelerometer and integral temperature sensor.

Ranger Pro Single Axis Sensor ISA100

70M301 – AA-BB-CC-DD

Description: Uniaxial wireless accelerometer and integral temperature sensor.

Ranger Pro Repeater ISA100

70M300 – AA-BB-CC-DD

Description: Wireless repeater.

Ranger Pro Tri-axial Sensor WirelessHART

70M403 – AA-BB-CC-DD

Description: Tri-axial wireless accelerometer and integral temperature sensor.



Ranger Pro versions 70M303, 70M301, 70M300, 70M403 use the same ordering information.

A: Mounting Hardware Options	
00	No Stud
01	M6x1 to M8x1.25 Tri-axial Alignment Stud
02	M6x1 to M8x1.25 Adapter Stud

A: Mounting Hardware Options	
03	M6x1 to M6x1 Stud
04	M6x1 to ¼-28 Adapter Stud
05	M6x1 to 10-32 Adapter Stud
06	M6x1 to 3/8-24 Adapter Stud
07	M6x1 to ¼-28 tri-axial Alignment Stud
08	M6x1 to 3/8-24 tri-axial Alignment Stud
09	M6x1 Epoxy Cementing Pad
10	Cementing tri-axial stud
B: Radio Option	
01	ISA100 or WirelessHART
C: Battery Option	
00	No battery
01	Battery supplied, not installed
D: Agency Approval Option	
01	CSA North America
02	ATEX/IECEX

Ranger Pro Installation Kit

130M5452 – AA

Description: Installation kit including battery installation tool, O-rings, wrenches, and USB readers.

A: Installation Package	
00	Installation Tools
01	Installation Tools and USB Reader
02	USB Reader only

System 1 Ranger Pro Device License

3071/13 – AA-BB-CC

Description: System 1 device license for Ranger Pro sensors installed for use with System 1. One device license is required per Ranger Pro sensor.

A: Not Applicable for Ranger Pro	
00	
B: Not Applicable for Ranger Pro	
00	
C: Ranger Pro Device	
00	## Number of licenses required

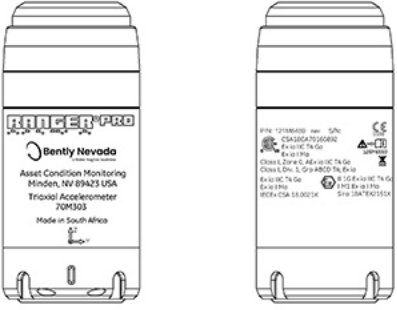
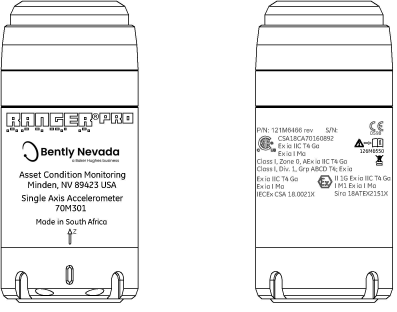
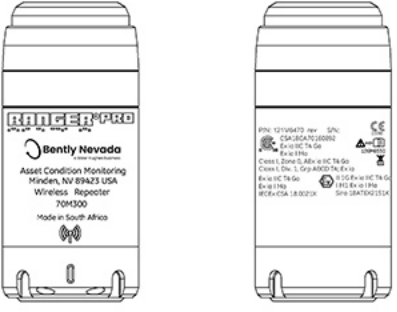

Option 3071/13 is only applicable to Ranger Pro devices that are installed for use with System 1. To order System 1, see **System 1 Software Package Datasheet** (document 108M5214). The AA option is only for vbOnline Pro device licenses. The BB option is only for 2300 monitor device licenses.

Catalog Order Number (1)	Part Number	Figure
70M303-XX-01-XX-XX	121M6469	 <p data-bbox="558 695 1471 758">Figure 1: Ranger Pro Wireless Condition Monitoring 70M303 Sensor Front/Rear Views</p>
70M301-XX-01-XX-XX	121M6466	 <p data-bbox="558 1129 1471 1192">Figure 2: Ranger Pro Wireless Condition Monitoring 70M301 Sensor Front/Rear Views</p>
70M300-XX-01-XX-XX	121M6470	 <p data-bbox="602 1564 1427 1627">Figure 3: Ranger Pro Wireless Condition Monitoring 70M300 Repeater Front/Rear Views</p>

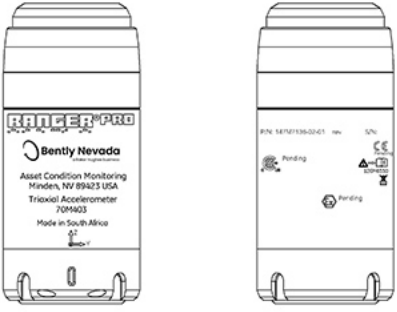
Catalog Order Number (1)	Part Number	Figure
70M403-XX-01-XX-XX	147M7136-02-01	 <p data-bbox="602 657 1425 720">Figure 4: Ranger Pro Wireless Condition Monitoring 70M403 Front/Rear Views</p>

(1) Customer order number

eDrawings and Figures

Dimensions are given in inches [millimeters] unless noted otherwise.

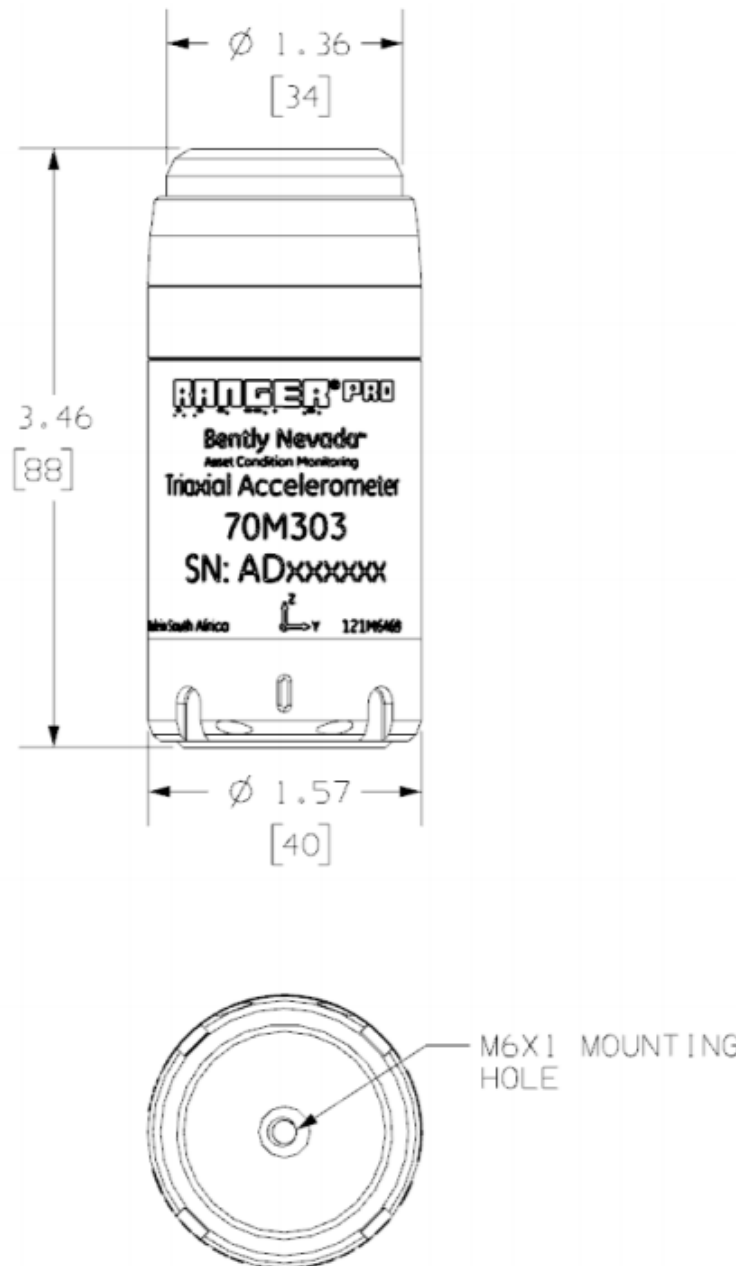

**Figure 1: Ranger Pro Wireless Condition Monitoring 70M303 sensor
(Identical specifications for the 70M300, 70M301, 70M403)**

Copyright 2020 Baker Hughes Company. All rights reserved.



Bently Nevada, System 1, Ranger and Orbit Logo are registered trademarks of Bently Nevada, a Baker Hughes Business, in the United States and other countries. The Baker Hughes logo is a trademark of Baker Hughes Company. All other product and company names are trademarks of their respective holders. Use of the trademarks does not imply any affiliation with or endorsement by the respective holders.

Baker Hughes provides this information on an "as is" basis for general information purposes. Baker Hughes does not make any representation as to the accuracy or completeness of the information and makes no warranties of any kind, specific, implied or oral, to the fullest extent permissible by law, including those of merchantability and fitness for a particular purpose or use. Baker Hughes hereby disclaims any and all liability for any direct, indirect, consequential or special damages, claims for lost profits, or third party claims arising from the use of the information, whether a claim is asserted in contract, tort, or otherwise. Baker Hughes reserves the right to make changes in specifications and features shown herein, or discontinue the product described at any time without notice or obligation. Contact your Baker Hughes representative for the most current information.

The information contained in this document is the property of Baker Hughes and its affiliates; and is subject to change without prior notice. It is being supplied as a service to our customers and may not be altered or its content repackaged without the express written consent of Baker Hughes. This product or associated products may be covered by one or more patents. See [Bently.com/legal](https://www.bently.com/legal).

1631 Bently Parkway South, Minden, Nevada USA 89423
Phone: 1.775.782.3611 or 1.800.227.5514 (US only)
[Bently.com](https://www.bently.com)